

A. K. Dutt's
**Silk and
Flower Magic**

Introduction

A. K. Dutt's

Silk and Flower Magic

Scripted by Mahadevananda

Illustrated by Someeran

Copyright © 1995 by Sam Dalal. All Rights Reserved.

Introduction

It was really a pleasure for me when I received a letter from Sam offering to publish my ideas in book format if I could give atleast 10 original routines. This really inspired me and I started working on them.

When I commenced my career in Magic - for a 30 minutes Act, I used to arrange a table full of Apparatus like you find in any dealer's show case. One fine day I met Magician Dynamic Ramesh (*I also call him the walking encyclopedia in Magic for his enormous knowledge, memory and command on the subject*) who suggested to me that I select a particular subject and perfect it, rather than perform an assortment of Magic. This transformed me completely.

Luckily I had two more brains, the better ones, one in my long time Magic partner Magician Zzesto and the other in Swami Mahadevananda, to give me tips and ideas when ever required. This is how I switched over to Flower and Silk Magic.

Though I don't claim anything original in this book, I have tried to blend two existing effects to create a new one, or to use the usual accessories like utility reel, pull etc., in some unusual ways or to position them in some unexpected places for un-expected purposes. Most of the tricks explained in this book are in one way or the other connected to body load methods and hence this book comes under that category.

Your suggestions are always welcome because, there is nothing we do today which couldn't be done a little better tomorrow.

If the reader finds pleasure in performing atleast one effect from this book, I feel I am suitably rewarded for the work and the efforts that I have put in.

That is all

Best wishes ;

Sincerely,

A. K. Dutt

The Half and Half Colour Change Record.

Contents

The Half and Half Colour Change Records	1
Card on Rope	5
Fifth Dimension Thimbles	6
Bare Handed Garland of Spring Flower Production	8
The A.K. Dutt Repeat Pull	9
Signed 20th Century Silks in Reverse	11
Knots in Sympathy	13
Shower of Flowers	16
Spots before your Eyes	19
Jumping Silks	20
Flash Production of Two Bouquets on Ribbons	22
A String of Pearls	24

The Half and Half Colour Change Record.

Effect. Magician shows a 45 rpm Record, **black** on both sides and an empty record cover, with a hole in the middle. He puts the record inside and then gives it to the assistant or lays it down.

A yellow silk is pushed through the center hole - and the record is removed with the silk to show it is now **yellow** on both sides. The silk is removed and the record replaced in the cover.

Magician now pushes the yellow silk into a small white ball with a hole in it. This ball is thrown into the air or to an assistant and when the silk is pulled out halfway it is seen to be still yellow.

The magician then gets his wand or powder and after he applies it, the other half of the silk is **Red**.

This diagonally dyed bicolour silk is pushed through the hole in the record and case. The record is removed and is now **yellow** one side, **red** the other!

Smiling now, the magician pulls out the silk, replaces the record in the case, and puts the half red half yellow silk into a second white ball. Rolling it between his hands, he applies more "Magic" to it and then pulls out the silk **all red**. This silk he pushes through the record cover hole, removes the record and shows it **Red** both sides and the cover empty!

Here is what you need for this effect. The records are -

1. One Record Black on one side, Yellow on the other.
2. One Record Yellow on one side, Red on the other.
3. One Record Red on one side, Black on the other.

(You can rig these up from a set of **Colour Changing Records**, or make them from board, with coloured paper.)

These are placed with the Yellow sides of

two records facing each other, and the two Red sides are placed facing each other. This results in a stack of 3 records with the outsides showing black.

The record(s) are put in the cover in the order

Black/Yellow - Yellow/Red - Red/Black.
(Fig. 1A)

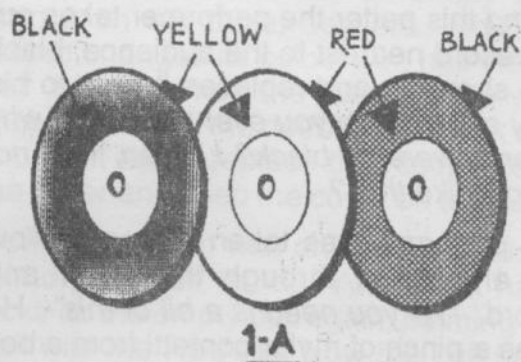

Next you require three Table Tennis Balls with holes cut in them. In one ball you put the red silk, in one the yellow and red diagonally dyed silk, with the yellow part showing. The third ball is empty.

Besides the two silks mentioned above (*one red and one yellow and red diagonally dyed*) you need one 12 inch yellow silk. This is kept with the records.

The empty ball is put with the records. The ball with double coloured silk is in the left side pocket, the ball with the red silk is placed in another pocket on the left side. A cover for the records. This is best made in heavy cloth or cloth reinforced card.

Presentation. Arun K. Dutt performs this effect in a serious, graceful manner. He does it silently to music. His wife assists with the presentation, moving with well practiced ease, handing Arun the items, catching the ball, holding the cover, making a perfect counterpoint to every move Arun makes.

If you have such an assistant and the style suits your personality this works extremely well. For those of us who are not so fortunate here is a presentation which may be easier and more suitable.

The performer picks up the record cover and takes out the black record, showing the cover to be empty, then replaces record in cover. He says *"Nobody buys these any more - it is all cassettes and C.D's nowadays. That's why I could get this one so easily, my (son, brother or whatever) threw this away with about 986 others he had spent my (or dad's) money on !"*

During this patter the performer takes out the record nearest to the audience, black side showing, and replaces it near to his body side. *Have you ever wondered why records were all black? I mean, why not Yellow, like this ?*

The performer has taken a small yellow silk and put it through the cover and record. *"All you need is a bit of this"*- He takes a pinch of mylar confetti from a box and sprinkles it over the record holder with the silk through it. *"And you see - it looks much better now"*.

The magician has pulled out the record with the silk still through the hole, and shows **both** sides are now Yellow. He pulls out the silk and then pushes the record back into the cover.

"And if you want to change the colour again" he says as he pushes the silk into a little white ball *"you only need to change the colour of the magic handkerchief, - here let's make it Red"*.

While saying this, he has taken another pinch of confetti and tossed it in the air and the ball also. He catches the ball and pulls out the silk half-way. It is still Yellow. *"Huh! Oh! It has **not** worked, needs a bit more powdered rainbow"*.

Taking another pinch of confetti (**and ditching the switched ball**) he sprinkles the Yellow silk half out of the ball. *"That should do it"* he pulls the silk out and only the part in the ball is red. *"Ahh, look at that only half red. Well anyway let's use it."*

He pushes the half and half silk into the record cover, making sure that the Yellow half is towards the audience and red closest to the body. Now he pulls out only the record which is Yellow one side and Red on the other. This is easy to do as it will be the one nearest to the audience.

All records are moved from the side away from you to the side nearest to your body throughout the routine, when the records are set up correctly.

"Hey! That's good! look at that, a two coloured disc - this is fun. Let's see now..." He pulls out the silk and puts the record back into the cover. *"I like this, - I'll do it again"*.

After putting the cover and record down, he now pushes the half dyed silk into the same ball getting the yellow half inside first - so the Red only shows in the hole.

Now he rolls the ball between his hands, switching the balls and takes another pinch of confetti from the box, dumping the half dyed silk at the same time. The red silk looks exactly the same as the half-dyed one did, so the switch is not apparent. *"This time I will not throw up the powdered rainbow, I shall sprinkle it on carefully and see - Yes! we have it all Red now"*.

Taking up the cover and record he pushes the Red silk through the hole, and pulls out the record showing the cover is empty as he says *"So now the record is all red too! Doesn't it look pretty? If you want some rainbow powder it comes in little packets from the Magic Dealers or if you really want to colour all the 986 other records you had better buy the half ton economy pack"*.

When picking up the cover with records in it, the yellow sides should be away from you, and the red sides nearest to you. Each time you show the record, it is put back on the side nearest to the performer.

The sequence of changes are as follows:-

1. Show the black record (**triple**) both sides and put in the cover.
2. Take the one nearest to the audience (**a single piece**) and put it behind the other

two in the cover. This now gives you two yellow surfaces on the stack.

3. Pull out all the three with the yellow silk and show both sides.

4. Pull out only the double coloured record which is the single one nearest to the audience, leave the others inside the cover.

The half dyed silk is through the records at this point. Put this record back on the side nearest to you. This now gives two red surfaces.

5. Take out all the records as one. They show Red on both sides and the cover can be casually shown empty. That is the finish.

A.K. Dutt's Handling: After the yellow silk is removed from the records, replace the record inside the cover. He holds it in his Left hand in hanging position, he picks a T.T. Ball (*with a hole*) in his Right hand from the table (*He uses a top hat for this purpose*) and at the same time, he palms the Ball with half Red and half Yellow silk in it.

Then his Left thumb and fore finger takes the empty Ball from his Right hand. Right Hand pulls the silk from the Left hand. Show the Ball in Left hand empty and then tuck the silk into it.

Collect the Ball in Right hand and perform the Bobo switch or the one-hand switch as

explained in Modern Coin Magic by J.B. Bobo - page no 10-12 (Fig 1B & 1C).

During the tossing motion, the balls are switched and the Left hand catches the ball with half Red & Half yellow silk.

Pull the yellow part of the silk and pretend (*by talk or by action*) as if nothing has happened. Your Right hand goes to the coat pocket or the box to pick up the Magic powder, the palmed ball is dropped and Magic powder is brought out. Sprinkle some powder on the Ball & Silk held in Left hand, pull the silk (*from your Right hand*) and it changes into half Red.

Now your Left hand has an empty Ball, drop it on the table, tray etc., Now the record changes its colour i.e., half Red & half Yellow. When the Record is in your Right hand, pull the double colour silk with your Left hand, replace the record inside the cover and keep the cover on the table.

Now you are left with only the silk. Bring it into your Left hand. Your Right hand picks up the empty ball again, palming the Ball with the Red silk. Now the Left hand takes the empty Ball & Right hand takes the silk as explained earlier.

Push the silk into the Ball, first yellow portion and then the Red. Take the Ball in your Right hand. Hold it between pinkie & Ring fingers.

Turn slightly towards your left i.e., right side of your body towards the audience.

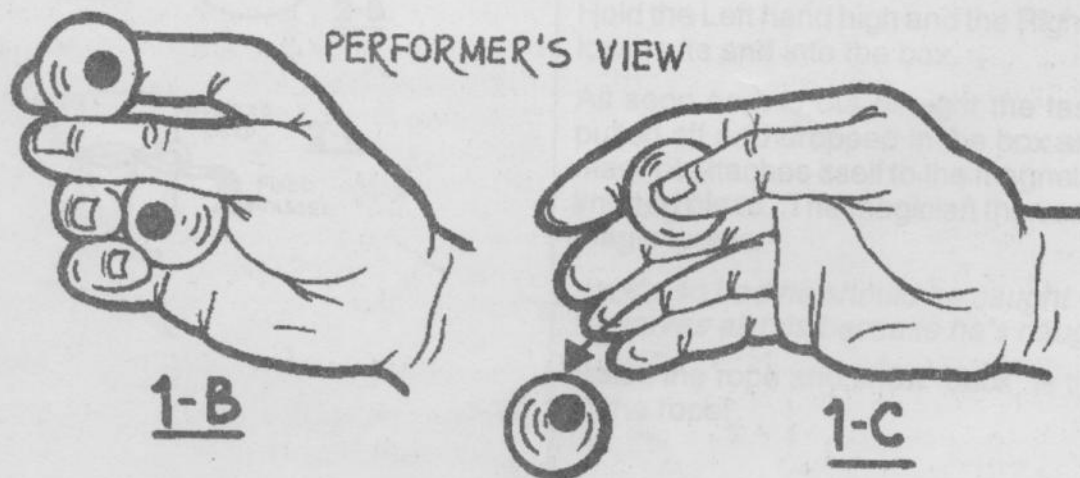

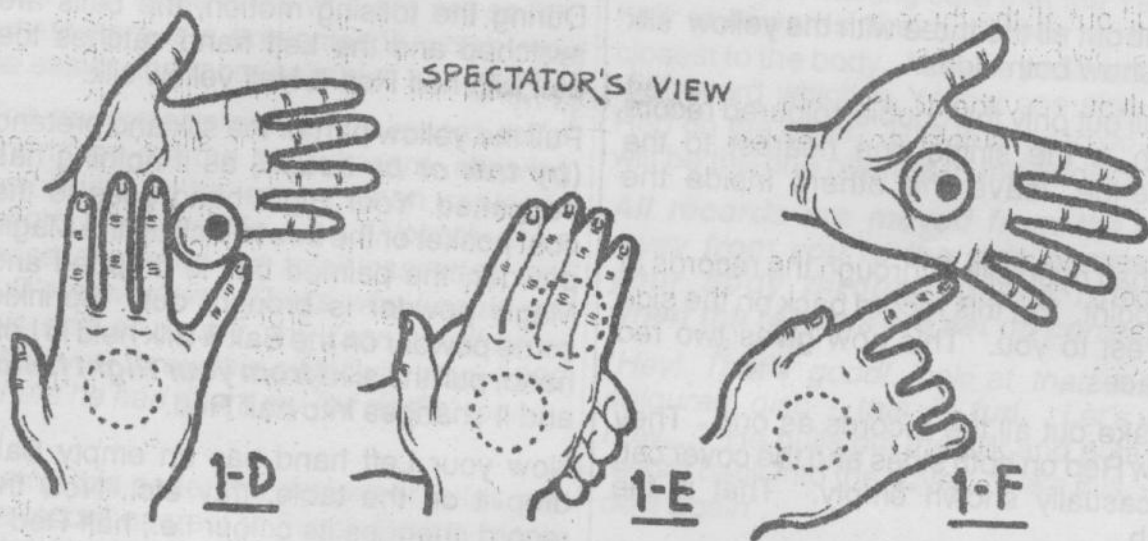

Left hand palm facing the audience. (Fig 1D)

Roll the Ball (*witl, double colour silk*) on Left hand from your Right hand and slowly move the Right hand outwards and the Left hand inward. (Fig. 1E)

This motion when executed properly causes the palmed ball to rest on Left hand palm and the ball with double coloured silk

is now palmed in the Right hand. (Fig 1F)

Audience now see only the Ball that is in the left palm. Go back to your pocket or box.

Right hand drops the palmed Ball and picks up the magic powder and the rest is the repetition of the first method and the silk changes its colour i.e., half red - half yellow to complete red.



Card on Rope

The sad story of Jack.

Effect. To a story about a bad boy, a card is chosen (**forced**) and lost in the pack.

A short rope with long tassels on each end is shown. The pack is dropped into a box and the rope is lowered into it. The "magic" is done, and the rope is lifted. The chosen card is now seen tied into a knot on the rope!

Method. *This old plot has been improved by adding the tassels to the rope ends, thus making it seem impossible to use magnetic rope ends.* Use a coloured rope and make the tassels from wool (yarn) of a different colour. Each tassel is two inches long.

At one end of the rope is a magnet. (Fig. 2A) One tassel is made with a flat headed screw in the center of it. See fig. 2B

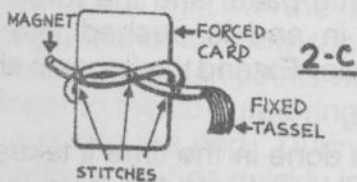
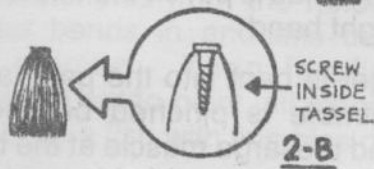

There is a separate short piece of rope tied into a knot that is large enough to encircle a card. The knot is stitched together to prevent it slipping. One end of this knotted piece has a magnet in it. The other end has a fixed tassel. Duplicate of force card is placed in knot. (Fig. 2C)

Working and Patter. *This is a story about a bad boy. Let us take one of these cards to be the boy (**force the Jack of Spades**). What card is it? Oh! it is the Jack. So we will call him Jack.*

Now Jack was always getting into trouble. In school he was very naughty, at home he was naughty and he picked his neighbour's fruit from his tree, he picked flowers in the park and climbed the trees there when the park keeper was not looking.

*One day the people all decided to catch Jack and punish him (**put the Jack of Spades back in the pack and shuffle it**).*

*They got some rope like this (**show the rope with false tassel in right hand**) and they went looking for Jack. But he was playing with so many other children that they couldn't see him (**Put the pack in the box**).*

One of the neighbours was a magician, and he lowered the rope in amongst the children.

Hold the Left hand high and the Right hand lowers its end into the box.

As soon as it is out of sight the tassel is pulled off and dropped in the box and the magnet attaches itself to the magnet in the knotted piece. The magician then said the magic words:

Jack's so bad he should be caught - he Deserves all this because he's naughty!

Raise the rope and show "Jack" is tied up in the rope!

Fifth Dimension Thimbles

The following routine uses a 12 inch wide plastic flat ring with a 5 inch hole in it. (Fig. 3A) By putting the hand into the hole - thimbles seem to appear from the fifth dimension on each finger until 4 have appeared.

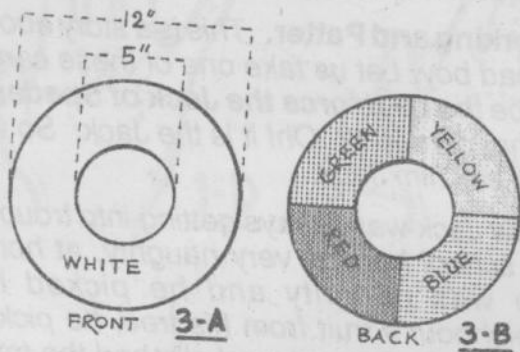

Then the white plastic ring is turned around and the other side has 4 coloured sections on it. (Fig. 3B)

The free hand is put in the hole, and comes out with 4 matching coloured thimbles. The hands are crossed across the chest and then lowered to show a large bunch of glitter (mylar) spring flowers resting on the palms.

I will list the equipment needed and the placement of it, and then give the series of moves which make up this graceful and pretty effect.

Requirements. You need 2 pairs of nested white thimbles (*Werry type*) making 4 white thimbles in all. One each of four coloured thimbles which match the colours on the plastic ring. Say Red, Blue, Green and Yellow.

These 4 coloured thimbles are placed in a holder which allows you to take all four together on the fingertips of the Left hand. The holder loaded with the thimbles is pinned to your trousers just under the jacket on the left hip.

A plastic ring as described above. This is held by your assistant or is on a pivoting stand, with the side of the plastic ring

facing the audience.

One pair of white nested thimbles is on your Right middle finger. The other pair of white nested thimbles is in the left classic palm position, the opening downwards.

The spring flowers with a nylon fishing line loop attached is pinned to the inside right side edge of the Jacket. The loop sticks out enough to allow the left thumb to catch in it. The flowers are level with the top pocket of the Jacket.

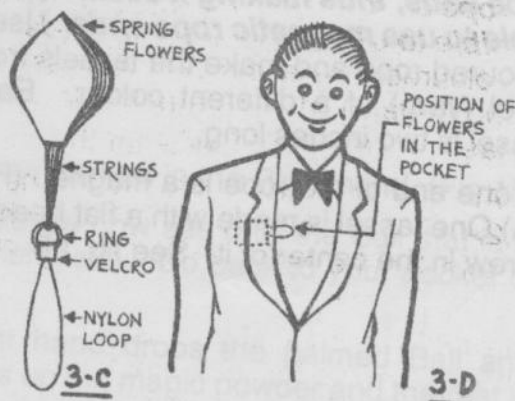

Routine of Moves. One pair of white nested thimbles is put on the Middle finger of the Right hand.

This finger is bent into the palm and the outer thimble is pinched between the finger and the large muscle at the base of the thumb. The outer thimble is gripped in a sort of thumb palm, and the forefinger then bends in and is pushed into the palmed thimble. Extend the finger to show two thimbles.

This move is done in the time it takes for the hand to be put into the hole in the plastic ring and removed. The hand goes to the hole showing one thimble and comes out showing two.

The second nested pair is in the **left** classic palm position. Using the left thumb and first finger, remove the thimble from the middle finger of the Right hand by taking

the extreme tip of the thimble and at that same time the right ring finger is put into the palmed pair in the Left hand. The ring finger bends into the palm and the pair of thimbles is thumb palmed in the Right hand. Then it straightens out.

After this move the Left hand moves the thimble from middle finger to pinkie, then the other thimble is moved from the forefinger to ring finger.

Right hand forefinger points to the plastic ring and the middle finger bends in to take the pair from the palm. The hand goes into the hole and then stretches out to show 3 thimbles.

Turn the hand palm outwards for a second to display - then turns back out again and the forefinger points to the hole. The middle finger now bends in to the same thumb palm position used in the first removal of the outer thimble. So the outer thimble is gripped by the thumb as before, and as the hand moves to the hole - the forefinger bends in to take the thumb palmed thimble.

Now turn the body slightly to the left and two movements are now made together. The Right hand goes in to the hole and the forefinger is straightened and removed showing the 4th thimble.

The Left hand simultaneously steals the 4 coloured thimbles from the holder. The forefinger bends in and this thimble is thumb palmed. Then forefinger is straightened out to point, all other fingers are bent into a fist, with thimbles on them.

The assistant now moves behind the Magician to his right with the ring and turns the ring around to show the 4 coloured segments. Magician points with Left hand forefinger to the coloured ring and moves the hand into the ring. During this move the forefinger bends quickly in to take the thumb palmed thimble and straightens out with **all the fingers to display 4 different coloured thimbles.**

Both hands are crossed in front of the chest, with all fingers straight and spread open. Palms are outwards. Then the hands are turned at the wrist so the backs

are outwards. Thumbs of both hands interlock.

During the move of turning the hands

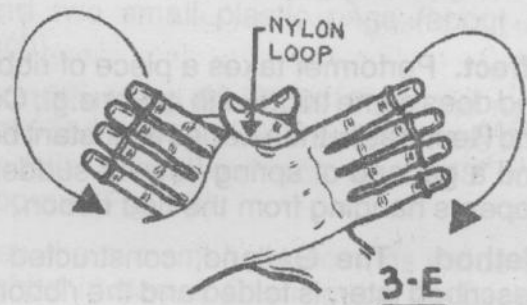

backs out-wards, the left thumb is engaged in the nylon loop of the flowers. (Fig. 3E)

The hands are turned, thumbs are locked and the fingers are wiggled. The flowers are pulled out of their pocket by a small semicircular movement of both hands, as they move forward about a foot. The flower bunch opens and rests on the outstretched palms. (Fig 3F)

The Flower Load : There are 18 large mylar spring flowers. They are placed into a pocket in the jacket at breast level. This is similar to a dove pocket. (Fig 3D)

The flowers have strings which are tied to a 1/2 inch plastic ring and a nylon loop 2 to 3 inch is tied to the ring. A small piece of velcro is stitched to the ring end of this nylon loop, (Fig. 3C) so that it can be placed and held accurately on the jacket where the other half of the velcro is put.

You will need to set the loop's position by trial and error, to find the place which most suits yourself.

Bare handed Garland of Spring Flower Production.

Effect. Performer takes a piece of ribbon and does some tricks with it. For e.g., Cuts and Restores it, then he ties an instant bow and a garland of spring flowers suddenly appears hanging from the tied ribbon.

Method. The Garland, constructed as described later, is folded and the ribbon is put around the flowers to keep them together, and emerge together from the holder. These are placed in a holder that is pinned to the hip, or it is put in a pocket in the edge of the jacket.

Performance. The loop of the nylon line is put at the front of the trousers at belt level.

When the bow is tied in the ribbon, the thumbs engage in the loop and then the arms are moved forward and sideways to pull the garland free and extend it for display.

After performing one or two small effects with the length of ribbon, the same colour as the 16 inch piece on the garland, tie an instant Bow Knot in the ribbon.

Pass both thumbs through the nylon loop and move the arms forward and spread the hands apart. The Garland will be pulled out of the holder and will open itself and hang from the Bow Knot between the hands.

The Spring flower Garland.

The spring flowers used in this garland are Standard Deluxe Size and made of mylar. Each flower has a pin hole through the bottom of the spring.

The flowers are threaded like beads on to a heavy nylon monofilament fishing line. They are threaded two at a time, then a large knot is made in the nylon line every two inches. This prevents the flowers from slipping into a single bunch. (Fig. 4A)

When a sufficient length is prepared (about 48 flowers over 48 inches), leave about 16 inches of nylon line on to which is threaded a 1/2 inch square of velcro passing twice through it. The other part of the Velcro is stitched inside the top front of the trousers, above the fly.

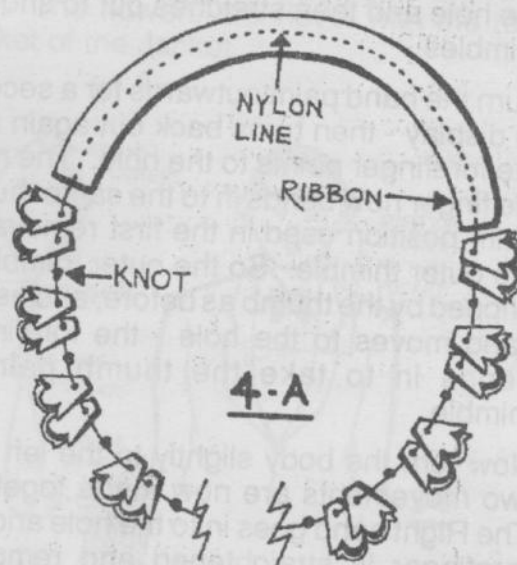

Attach a one inch wide ribbon to each end of the flower length, running alongside the nylon line.

A holder similar to the one used in **Shower of flowers** in this book is placed on the right hip of the trousers.

Fold the flowers and put the ribbon around the flowers to hold them in position (Fig. 4B). The flowers (garland) are then put in the holder and the same is attached to the trousers.

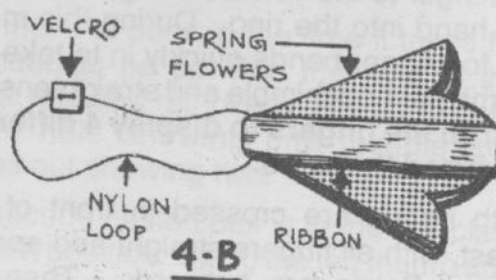

The A.K.DUTT Repeat Pull

The improvement that has been made to the normal Pull used for so many years is one that makes it possible to use the same pull repeatedly in the act.

Whatever item has been vanished with the pull, can be retrieved in a split second, and disposed off, and the pull is ready to use again any time you wish.

Here is the way a **basic pull** is adapted. First the pull is made in the normal way. A wrist strap made of leather, buckles to the left arm. The strap has a ring on it at one side in the center of the strap. (Fig. 5A).

A nylon fishing line is attached to this ring. This nylon chord passes through a Belt loop of the trousers at the back.

You need a **Utility Reel** with a small plastic washer on the end of the Reel's line. The hole in the washer is big enough to put the

Pull's nylon chord through it. A nylon line and two small plastic rings (about 1/2 inch).

Constructing the Pull. Pass the nylon cord line through the washer on the Reel and tie a loop on each end. 48" long approx. (Fig. 5B).

Sew the two small plastic rings inside the right shirt sleeve. One is put at the back of the armpit and the other just above the elbow bend.

Thread one loop of the nylon chord line through the two small rings in the sleeve, then through the belt loop and it then goes to the wrist strap to the left. (Fig. 5E) Attach it to the strap as follows:-

1. Pass the loop through the ring on the strap, then push the strap through the loop. This interlocks the nylon cord line to

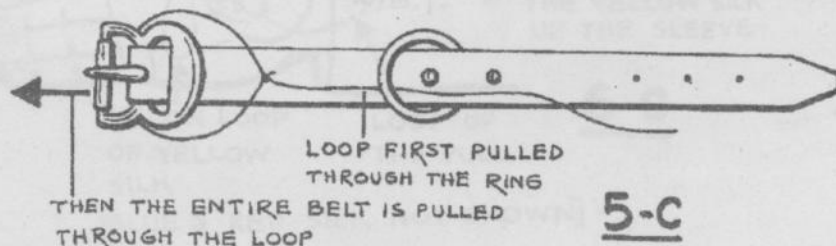
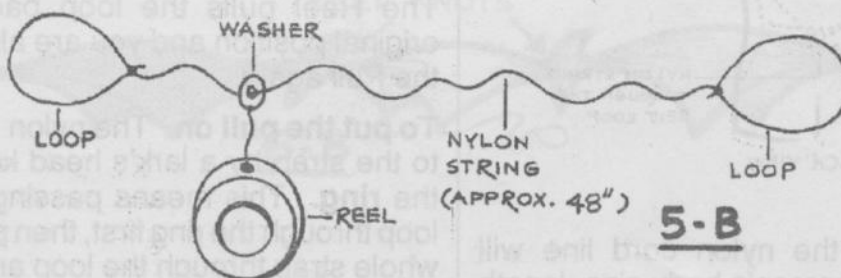
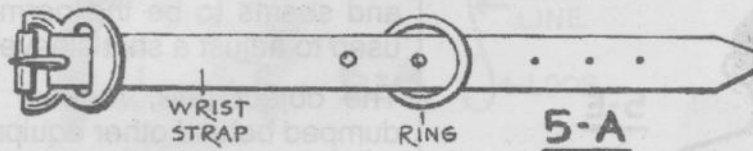

the strap. (Fig. 5C)

To remove, you reverse the proceedings, which frees the strap.

2. The reel is near the other loop at the right hand, below the two shirt sleeve plastic rings. Make a small pocket in the cuff of your shirt, or just above it, to put the reel into. Have a flap on the pocket which can be buttoned over the mouth of the pocket. This will prevent the reel moving around. (Fig. 5D)

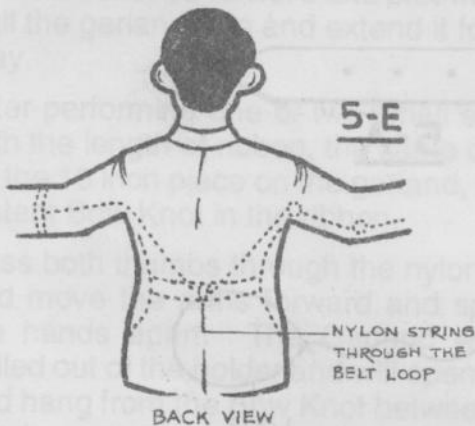
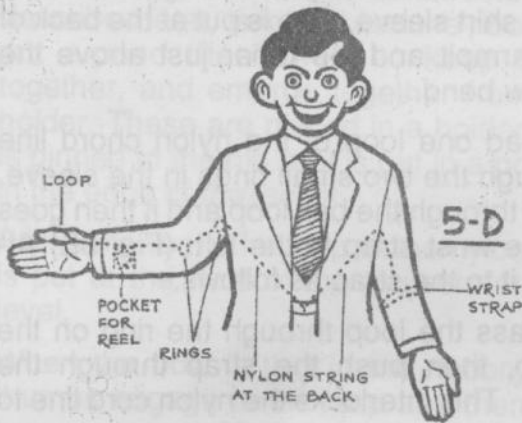

The length of the nylon cord line will depend on the person's body size, length of arms etc., so it is best to follow these instructions which Marconick gives for his pull.

"Stand with your elbows well tucked into the sides, with only the forearms out-stretched. Now get a friend to adjust the length of the cord so that the loop of the pull rests on the right thumb. The cord should be in a tight position."

Now, the loop of the pull is positioned just inside your right coat sleeve. Whenever you need to use the pull, put your left middle finger in your right sleeve, get hold of the loop and slip it over the right thumb (practice will make this loop easier to find, so you can instantly get hold of it).

The plastic rings in the sleeve will prevent the loop moving around too much, even when it holds a vanished object. The rings also prevent the object from dangling down behind the coat.

To use the pull repeatedly. Whenever you wish to discard the vanished item, put your left middle and forefingers up the right sleeve, catch hold of the object and pull it out. This takes just a fraction of a second and seems to be the normal movement used to adjust a shirt sleeve.

The object (*silk, rope or whatever*) is dumped behind other equipment or into a well or servante etc., in the act of taking or putting some other prop into position.

The Reel pulls the loop back into its original position and you are all set to use the Pull again.

To put the pull on. The nylon is attached to the strap by a lark's head knot around the ring. This means passing the small loop through the ring first, then passing the whole strap through the loop and pulling it tight.

Reverse these moves to remove the nylon line.

Signed 20th Century Silks in Reverse.

Effect. A person from the audience is asked to sign their name (or put their *Swiss Bank Account Number*) on a 12 inch Yellow silk with a marker pen.

The performer picks up a red and a blue 15 inch silk in each hand and ties the signed yellow silk between them. The three tied silks are bundled up and tossed into a large paper cone held by a volunteer or assistant.

The performer now picks up an 18 inch half silk and ties a knot in it. At the moment the knot forms, the signed yellow silk appears in the center of it.

The Red and Blue silks are removed from the cone and are found tied together! The cone is empty.

Equipment and Working. You need a pull. *A.K. Dutt's Repeat Pull* or any other pull will suffice.

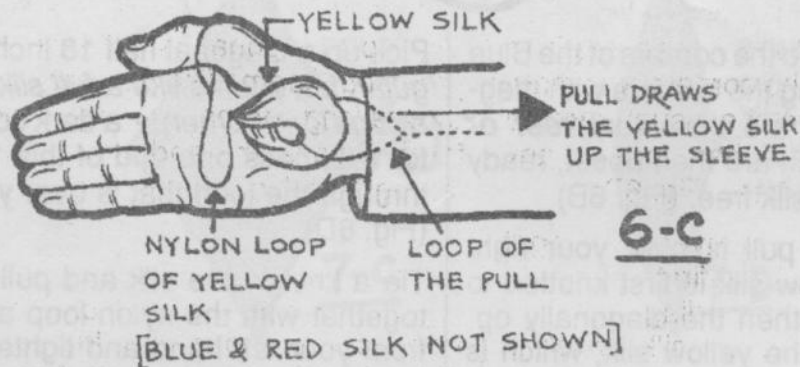
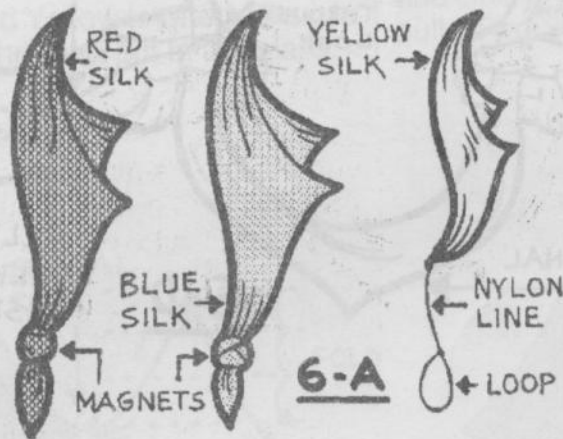

Also a Red and a Blue 15 inch silk. In the corner of each of these silks you tie a small magnet. Leave 2 inches of the corners free after the magnets are tied in - See fig 6A

A yellow 12 inch silk has a thin nylon line tied to one corner. The nylon line is then made into a loop and a sliding knot is tied. (Fig. 6A). The loop should be about 6 inches long. Tie a knot in the nylon line to prevent the loop from tightening too much on the thumb.

bundle the silks up, pull the yellow silk off the others. When the bundling is completed, pass your right thumb through the nylon line loop on the yellow silk. (Fig 6C)

Lastly, you place the two magnets together, and toss the bundle a short distance into the paper cone. The action will draw the yellow silk up the sleeve, and because the silk is now attached to your thumb by the line loop, it will be released from the pull automatically. It rests inside the sleeve.

PERFORMER'S VIEW

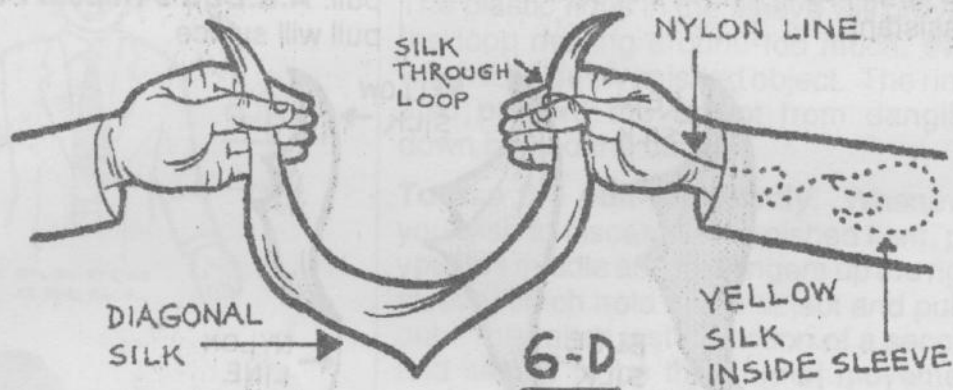

PERFORMER'S VIEW

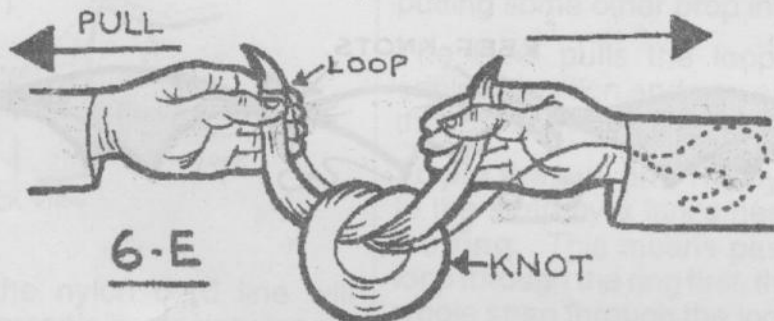

Tie the yellow silk to the corners of the Blue and Red silks using the corners with magnets. The knots are the usual reef or square knot which are then upset, ready to pull the yellow silk free. (Fig. 6B)

The loop of the pull is over your right thumb. The yellow silk is first knotted to the red silk, and then the diagonally opposite corner of the yellow silk, which is free, is passed through the loop of the pull, and then it is tied to the blue silk. As you

Pick up a diagonal half 18 inch silk (triangular, but seems like a full silk when held by one long corner), - a dark colour is best for this, pass one end of this 18 inch silk through the loop that is over your thumb. (Fig. 6D)

Tie a knot in the silk and pull the corner together with the nylon loop along with it from your left hand and tighten the knot. This will pull the yellow silk from the right sleeve and into the knot. See Fig 6E.

Knots in Sympathy

Effect. Basically the plot is Sympathetic silks but with a different handling and a flash finish.

A Red silk is tied to a yellow silk and put into a wine glass. A Green silk and a yellow silk are removed from a second wine glass and tucked separately into the top pocket of the performer's jacket.

The Red and Yellow silks are now removed slowly to show they are separate and the Green silk is jerked out of the top pocket with the yellow silk knotted to it.

These Green and Yellow knotted silks are now rolled together and put in the glass.

The Red and Yellow pair is placed quite separately across the palm of the Right hand. All ends are visible.

The Green silk is now lifted from the glass and shown free of its yellow mate, and then the magician makes a gesture with his Left hand towards his right, and the Right hand tosses the silks out to have them instantly join together. The pair are held only by one corner of the red silk.

Equipment and Preparation. You need 4 yellow silks 12 inch size and One Red and One Green 15 inch size. The A.K.Dutt pull. Two Stemmed wine glasses.

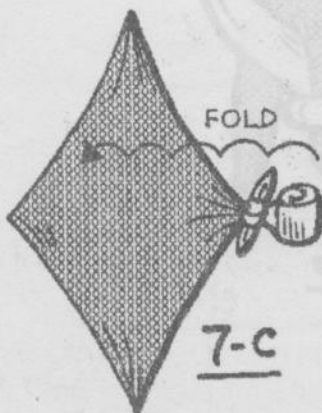
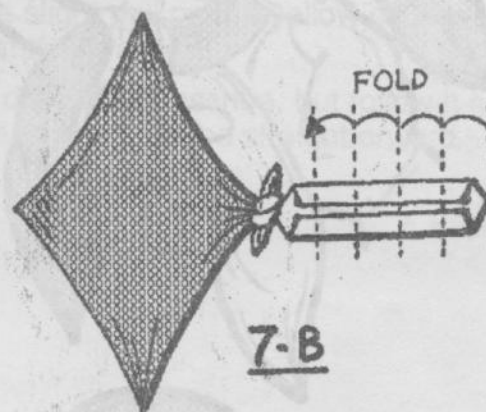
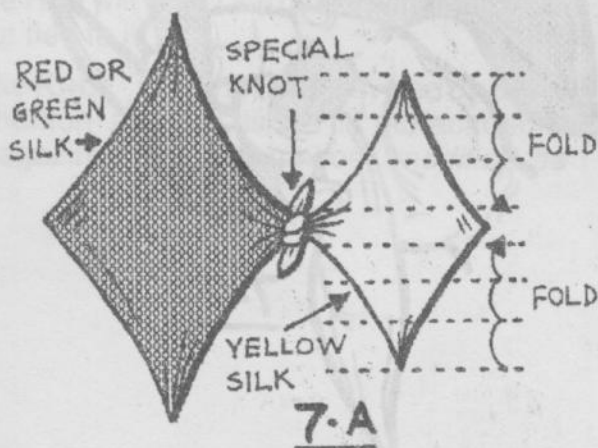

Tie one yellow silk to a corner of the red silk using the knot given below. Roll the yellow silk into a thin strip, (Fig. 7B) then fold and roll it into a small bundle right up to the corner tied to the Red silk. Continue to roll the bundle into the Red silk (Fig 7D). Put this prepared red silk with another yellow silk into one glass.

Prepare another yellow silk with the green silk in the same way as the Red and Yellow above. Put this green with another yellow silk into the other glass. Strap the pull on so the loop comes to the right hand thumb.

Working. Take the Yellow and Red pair of silks from the glass and show them separately, one in each hand.

Tie them together, using the knot given

below. Then when putting them back in the glass, pull them slightly to upset the knot, and open it as it is bundled up.

Pick up the second pair (*Green and Yellow*) from the other glass and put the Yellow one first into your top outside breast pocket of your jacket. Then holding the corner of the green silk which is at the center of the rolled silk, push the green silk down on top of the yellow. Keep the center corner showing above the top of the pocket.

Make a "Magic Pass" gesture from one pair of silks to the other, and gently lift the Red and Yellow silks out of the glass separately.

Yank the Green silk from your top pocket

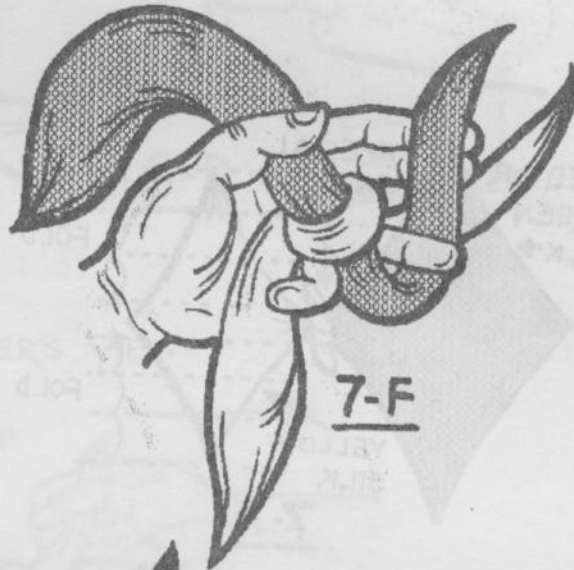

quickly so it unrolls fast and the Yellow silk is seen tied to it. Roll up this pair (*pulling them apart as you put them into the glass again*).

Take the Yellow of the other pair and pass it through the pull loop. Leave it lying across your palm near to the wrist and not over the thumb. Place the Red silk over the palm, but clearly some way from the Yellow one.

Do the "Mystic Pass" business again and lift the Green and Yellow out of the glass singly.

Now grip the center corner of the Red silk firmly between the fingers of the Right hand and make a throwing forward motion, turning the hand palm down at the same time. The left arm is stretched out at the same instant the right arm throws the Red and Yellow silks into the air.

The Yellow silk will go up the sleeve and the Red will unroll and the Yellow will drop out tied to it.

The Knot. This knot was devised by Chris Charlton and published in *Abracadabra* magazine. The description (*modified as*

applicable to this effect) is reproduced below.

"... Let us assume you have a red silk in the left hand and a yellow silk in the right hand and are going to tie them together.

First tie a simple overhand knot as in Fig. 7-E. Note the position of the third left fingertip which is extended beneath the knot.

Release the red corner with your right hand and take the yellow silk a little to the right of the knot and pass it around that third fingertip of the left hand, thus forming a loop, the body of the yellow silk being passed forward over the red corner to hang in front, as in Fig 7-F.

The final position should look like Fig. 7-G.

Complete by tying a second overhand knot with the two corners. You have a knot now which, when pulled reasonably tight, will be very firm when the red silk is shaken, but a slight pull on the yellow causes it to instantly unravel.

It is difficult to describe, but follow it silks in hand and it will be straightforward."

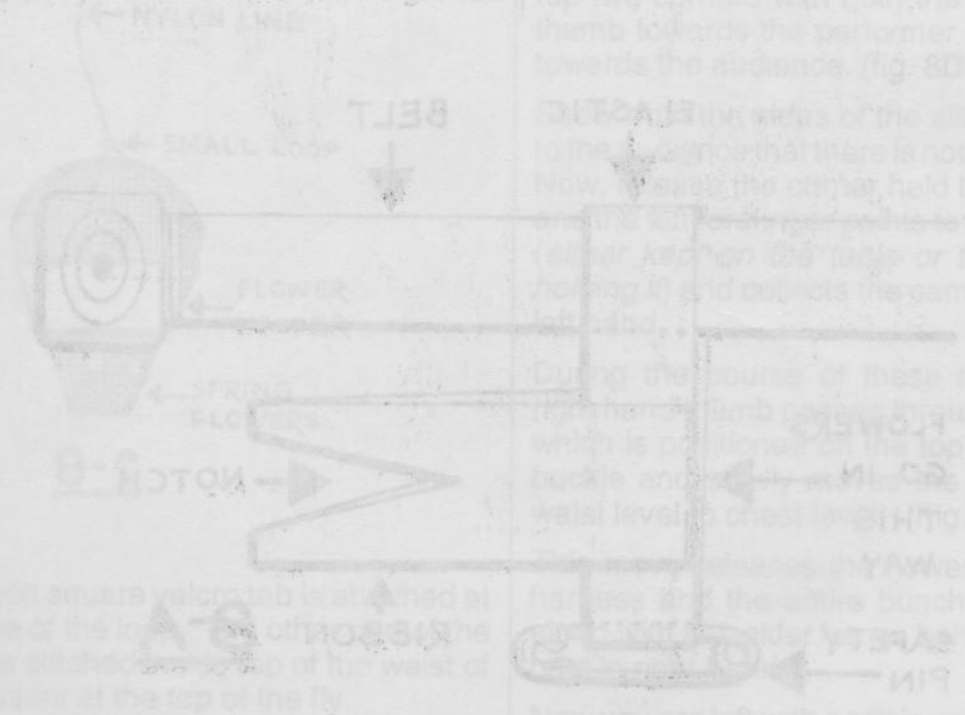

Shower of Flowers

The effect of this item is so pretty and surprising that it is best performed without much patter. It is rather like a Dove production except that it has the very quick burst of flowers instead of a flapping bird.

The magician holds any silk about 18" or 24" in size or more. He reaches for a second silk and places them together, away from his body and furniture.

Doubling these silks up in his two hands, he then holds them in one hand only and suddenly a stream of 50 Mylar flowers jump high into the air, falling down all around in a magnificent shower.

Equipment and Preparation : The flowers are mylar spring flowers, Fifty loose flowers without strings. They are put into a self-releasing holder, which is then put into a small harness on the hip.

To make the belt-harness, take a piece of 1 inch wide black elastic 10 inches long and double it. Stitch the ends together.

Stitch it one inch in from the stitched ends to make a belt loop. At the opposite end of the 5 inch loop stitch 1/4" from the end.

This is to hold a safety pin which will keep the bottom of the loop from moving, when pinned to the trouser leg.

Cut a piece of black ribbon 1 1/2 inches wide and 10 inches long, stitch each end around the black elastic loop. This makes a right angle loop of ribbon on the elastic. Cut a 'V' shaped notch in this ribbon (see Fig 8A).

The purpose of this notch is to prevent the flowers from slipping out of the sides of the holder or harness. The base of the spring flowers is pushed through the notch.

This harness is worn at the hip and pinned to the trousers. If the trousers are not black, make the holder to match the colour of the trousers you wear.

The Flower Holder

It is made of a piece of 1 inch Nylon tape approximately 8 inches in length. It is folded into half and stitched tapered as shown in Fig. 8B.

At points - a, b & c, eye-lets are formed by sewing thread which allows the Nylon to

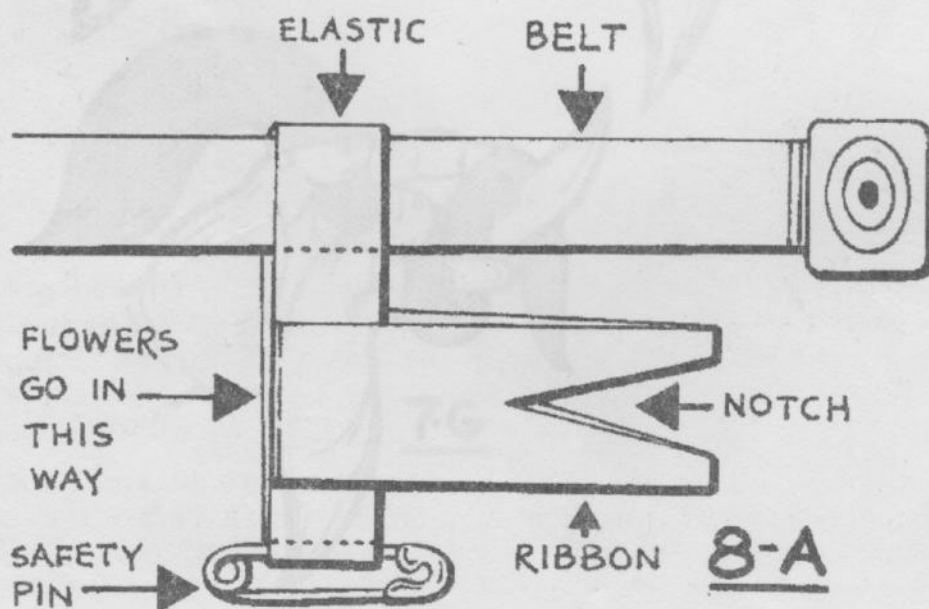

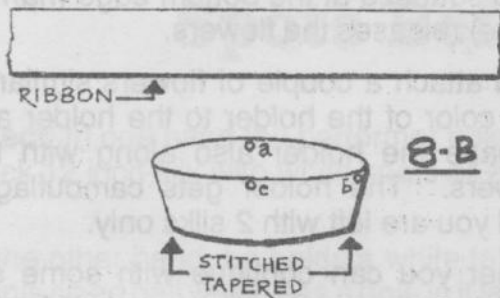

pass freely through them.

Now, a Nylon string is passed through the eye-lets in the order a, b and c. Then a 1/4 inch loop is made at one end and the other end is passed through the loop and a 2 inch loop is made at the other end (Fig. 8C).

The length of the Nylon after making the loops and loading flower into it should be the length from your hip to the buckle of your belt plus an inch more.

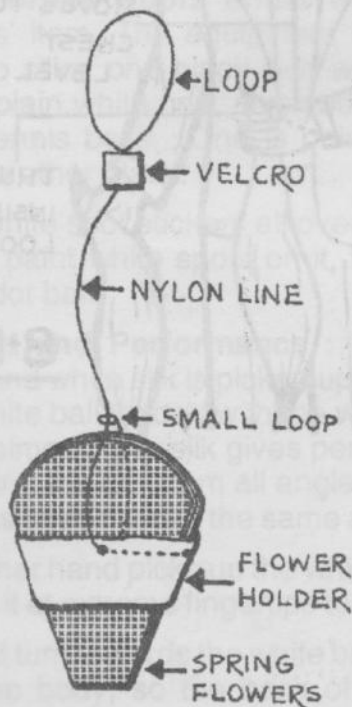

A 1/2 inch square velcro tab is attached at the base of the loop. The other part of the velcro is stitched inside top of the waist of the trousers at the top of the fly.

Loading the Flowers in the Holder

The base of the spring flowers are pushed in at the widest side of the holder. The Nylon thread is then pulled up over the top of the flowers. (Fig. 8C). In this condition, the bunch and holder is loaded into the belt harness.

The velcro is attached to the front of the waist band. The loop is left sticking out for the load to be lifted up into a silk.

The flowers are held by the nylon pressing at the top of the bunch. The weight of the flowers (50) keeps the tension when the bunch is lifted by the loop.

As soon as the bunch is rested on the palm, the nylon tension is released and easily pushed to the side by the flowers beginning to open. By squeezing the bottom of the flowers, they are caused to spring all at once into the air.

A slow shower can be made by holding the hand around the bunch of flowers, and releasing them by pushing with the thumbs.

Showers of Flowers - Presentation

Take any 18 or 24 inches silk and hold the top two corners with both the hands with thumb towards the performer and fingers towards the audience. (fig. 8D).

Show both the sides of the silk to convey to the audience that there is nothing inside. Now, release the corner held by left hand and the left forefinger points towards a silk (*either kept on the table or to assistant holding it*) and collects the same with your left hand.

During the course of these moves, the right hand thumb passes through the loop which is positioned on the top of the Belt buckle and slowly moves the hand from waist level to chest level. (Fig. 8E).

This move releases the flowers from the harness and the entire bunch of flowers along with its holder hangs behind the silk held in right hand.

Now you are left with a silk in your left hand

and a silk and shower of flowers with its holder in your right hand. The silks are gathered and the flowers rest on the palms of both the hands but still concealed under the 2 silks.

The Nylon string of the flower holder is arranged in such a way that once the flowers are rested on the palms the tension of the springs of the flowers pushes the Nylon sideways and a mild push or a

mild squeeze at the bottom edge (*narrow edge*) releases the flowers.

You attach a couple of flowers similar to the color of the holder to the holder and release the holder also along with the flowers. The holder gets camouflaged and you are left with 2 silks only.

Either you can continue with some silk effect or discard the same and go for the next trick.

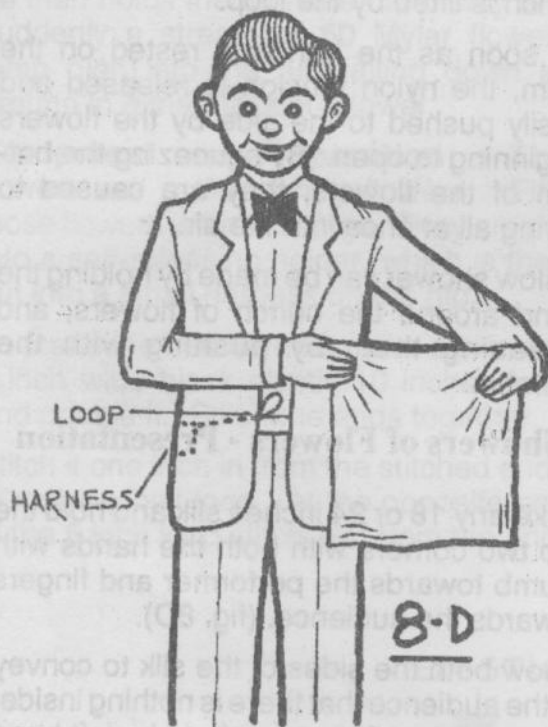

Spots Before Your Eyes

Effect: In one hand the performer holds a black 12 inch silk with white spots all over it.

In the other hand, he holds a white table-tennis sized ball which has a hole in it large enough for a fingertip to enter.

The black and white spotted silk is pushed into the hole in the ball. This ball is then rolled between the palms of the two hands. The ball is seen through.

The performer now reaches for some magic salt or for a wand. The 'magic' is done, and the fist opened to show a black ball with white spots!

From inside, the ball, the performer pulls out the silk which is now plain white!

This would make a nice addition to **Metamorpho spots** effect which is a dealers' item. The equipment needed is the two silks, one black with white spots and a plain white one, plus you need two table-tennis balls. One is painted white and the other black.

Stick white spot stickers all over the black ball or paint white spots on it, to make a polka dot ball.

Method and Performance : When the black and white silk is picked up, the black and white ball loaded with the white silk is also palmed. The silk gives perfect cover for hiding the ball from all angles. Even if a part is seen it looks the same as the silk.

The other hand picks up the white ball and shows it at extreme fingertips to be empty.

A slight turn towards the white ball is made with the body, so the back of the hand

which holds the black and white silk faces the audience.

The B & W silk is now pushed into the white ball. This ball is then put between the pinkie and ring fingers of the hand palming the B & W ball.

The empty hand is held palm to the audience with the heel of the palm (*by the wrist*) touching the fingers of the hand holding the two balls. Roll the ball(s) between the palms until the B & W ball is in the center of the palm facing the audience. This hand closes around the B & W ball, and the other hand palms the white ball.

(*This is the same move used in Colour Changing Records effect in this book.. See Fig.1D, 1E, and 1F*)

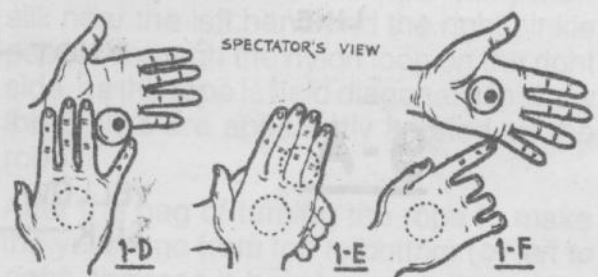

The hand palming the white ball reaches for the wand or magic salt and ditches the ball. The eyes of the performer are of course always on the other hand which holds the B & W ball.

Now the 'Magic' is done and hand opened slowly, showing the change.

Performed silently, this is a very surprising and swift change.

Jumping Silks

Effect & Patter: The magician picks up a length of rope which has three 12" to 15" silks tied on it. On the left are two red ones and at the right is one yellow silk.

"I would like to show you my trained handkerchiefs" says the magician as he holds the rope at a diagonal angle. "See this yellow one at the top? I have trained this

"kerchief for the last three months to do this trick."

The performer turns around and then turns back to face the audience. 'See, the yellow one - his name is Joey by the way, has now jumped from the top to the bottom'. Sure enough, the yellow silk is now at the bottom under the two red ones.

SPECTATOR'S VIEW

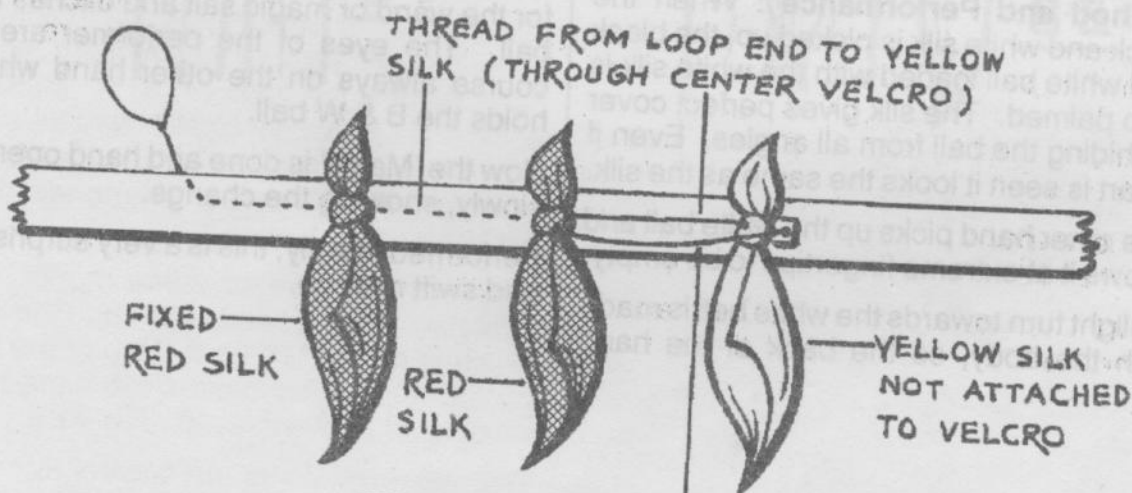
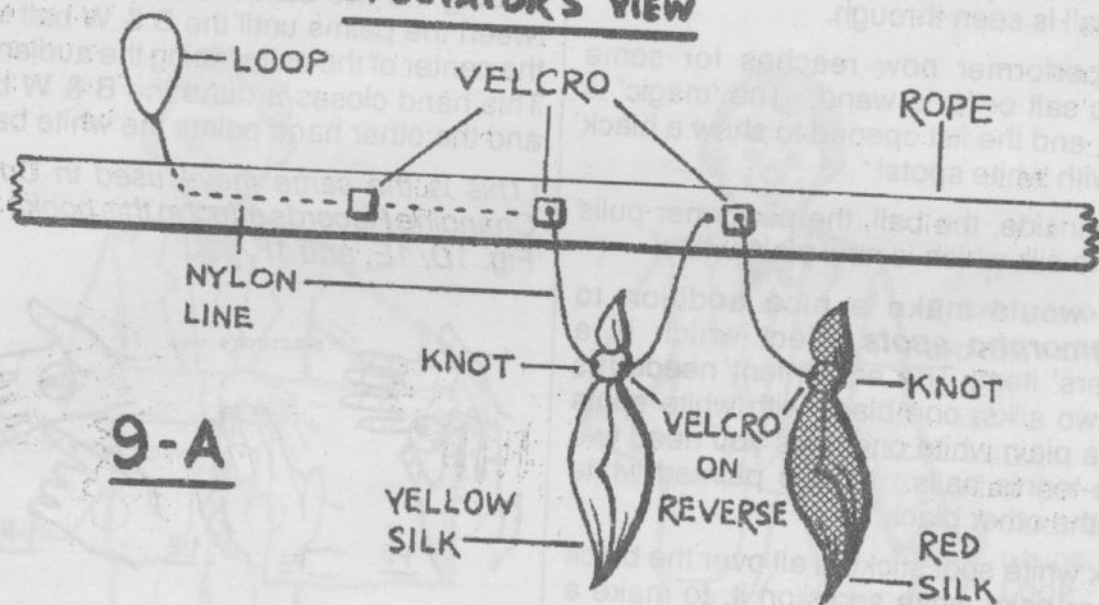

SPECTATOR'S VIEW

'Joey loves doing his trick - watch - he will do it again for you'. This time the magician once again turns around and then turns back to face the audience. This time yellow silk is at the top again.

'Isn't he clever, give Joey a big clap - what? - Turned it around? No! look as Joey does it again'. The performer turns around and then turns back again and again the yellow silk jumps.

This is repeated until everyone is shouting that he is just turning the silks over behind his back.

Now the magician holds the rope horizontally as he says, 'You don't believe Joey is really jumping? OK. I will prove it to you - just watch'. He makes movements with his head sideways as he says 'Come on Joey - do it once more for me'. The yellow silk now **visibly leaps to the center of the rope and the center red silk moves to the end.**

'There, you see; Joey did it - Give him a big clap for being so good'.

Equipment and Construction: All 3 silks have a knot 2 inches from one corner. One cm. square Velcro tabs are stitched to each silk. The other half of velcro is on the rope at 6 inches intervals along it. One red is permanently positioned at the right side (*performer view*) and the second red is the traveling silk.

This has a nylon thread knotted into the knot and comes out from the center of the velcro piece and passes through the center of the velcro on left side of rope (*performer view*). The thread passes through

the center of the rope for 1/2 inch and then comes out and goes into the yellow silk at the velcro tab.

Another thread (nylon) comes out from the velcro tab on the yellow silk - this thread passed through the middle of the central velcro on the rope - it then passes inside the rope to the right side.

About 4 inches to the right of the last velcro tab this thread comes out of the rope and has a loop tied on the end which is about 2 inches from the point where it comes out of the rope. (Fig. 9A)

The yellow silk is pulled to the left side. The thread of the red silk passes under the yellow one and is attached to the center tab of velcro on the rope. (Fig. 9B)

This completes the preparation. The rope can now be left lying on the table until the performance.

To Perform: Pick up the rope with yellow silk near the left hand and the right pinkie passes through the nylon loop on the right side, as the rope is held diagonally to show the 3 silks are apparently knotted on the rope.

After the gag of turning the rope to make the yellow go from top to bottom (*or left to right*), the rope is held horizontally and the right hand is slid along with rope, pulling the nylon thread about 6 inches. Left hand keeps a firm hold on the rope at left side.

The hands are both moved forward slightly as the thread is pulled. The yellow and center red silks exchange places rapidly and end on the velcro tabs so they appear tied on the rope.

Flash Production of Two Bouquets on Ribbons

Effect : The magician shows a 40 inch long gold ribbon 1 1/2 inches wide. It unrolls from his hand and he waves it in the air, then ties a knot in it .

As he sharply tugs the ribbon to tighten the knot, a bunch of mylar spring flowers appear tied in the knot.

Holding this bouquet between his hands, he moves his hands apart - suddenly, and a second bunch of flowers appears with an identical gold ribbon on it. He now stands with a bunch of flowers in each hand, ready for applause, as he bows.

Equipment & Method : 2 bunches of 18 spring flowers with strings attached and 2 ribbons each approx. 40" long.

Flower Bunch No. 1 (Fig 10A) has a 1/2 inch plastic ring attached to the strings. The ring and strings are covered with a small silk sleeve. This is to prevent the ring or the strings being caught on the buttons of the shirt sleeve.

A nylon thread is attached to the plastic ring through the sleeve. The other end of the 9 inch nylon thread is sewn to the ribbon 4 inches from one end. The thread is sewn on the middle of the ribbon, and a small patch of ribbon may be put over the thread so it cannot be seen, but this is not absolutely necessary.

On the nylon thread is a 1/2 inch square tab of velcro, so it can slide along the thread. The other half of the velcro is sewn to the shirt sleeve on the side nearest to the body, one inch from the edge of the shirt cuff.

The bunch of flowers is pushed up inside the sleeve, and then the ribbon is rolled up from the loose end and put inside the shirt sleeve after the tab of velcro has been fixed to the sleeve. This will hold it in place.

Make sure that the nylon thread does not double back on itself as this loading is

done in the sleeve.

Flower Bunch No.2 (Fig. 10B). This is prepared in the same way as No. 1, with a 1/2 inch plastic ring and sleeve of silk over it, but the velcro tab is put on the silk sleeve at the end away from the flowers.

The other half of the velcro is stitched inside the shirt sleeve of the other arm. A nylon thread 3 or 4 inches long is put on the ring and then goes to the other ribbon which is knotted in the center. The thread is put in the middle of the knot on the ribbon and the other end has a loop large enough to pass a thumb into.

A half inch tab of velcro is put on the point where the loop joins the thread. The other half of the velcro is stitched to the jacket sleeve and the velcro on the ring is fixed to the piece on the jacket. Roll up the two loose ends of the ribbon and push this roll into the shirt cuff half way.

Performance : Pull the rolled ribbon from the bunch No.1 out of the sleeve and hold it in the hand with bunch No.1 in its sleeve. Let the ribbon unroll, then take the ribbon across the palms of the hands and tie a knot loosely in it.

The ends are exchanged so the end with the nylon attached remains still at shoulder level as the other hand pulls sharply downwards on the other end of the ribbon. The bunch of flowers will be drawn to the center of the knot instantaneously.

Holding the bunch of flowers flat on the hand with the second load hidden in the sleeve, put the free hand on top of the flowers palm down, thumb nearest to the sleeve where the loop is sticking out.

Put the thumb through the loop of the 2nd bunch of flowers and move the hand forward quickly in line with the sleeve. The 2nd bunch will now be pulled over the top of the flowers on the palm.

Grip the first bunch of flowers with the fingers which hold it so it is not pulled off the palm by the 2nd bunch as it moves over it.

Each hand now holds a bunch of flowers

with ribbons hanging from it. Bow to the audience.

The presentation is left to the individual, as it can be performed silently, or with any patter you may find suitable.

FLOWER BUNCH NO. 1

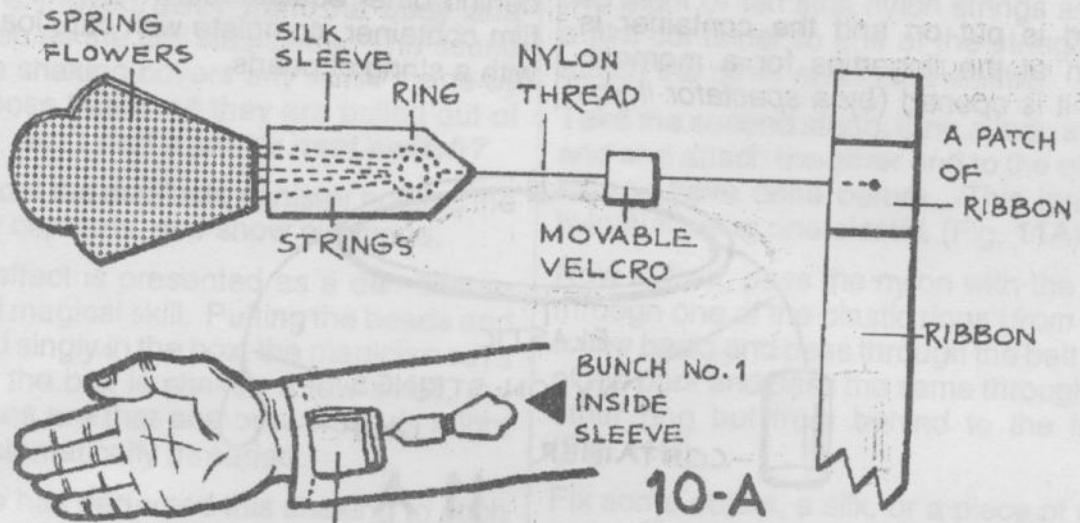

YOU SHOULD TUCK THE RIBBON INSIDE THE CUFF OF THE SHIRT

FLOWER BUNCH NO. 2

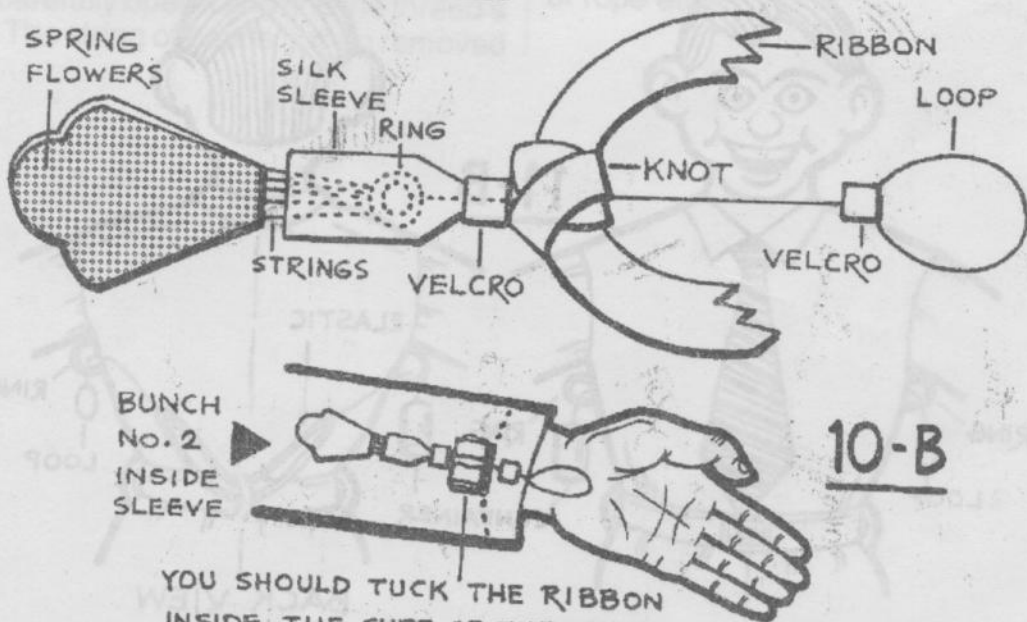

YOU SHOULD TUCK THE RIBBON INSIDE THE CUFF OF THE SHIRT

A String of Pearls

This is a quick little effect which is pretty to watch, and is pretty in it's simple method.

Effect: Holding a small plastic container (a 35 mm film container), the performer pours or drops slowly a number of loose pearls and a length of thread.

The lid is put on and the container is shaken at the fingertips for a moment. When it is opened (by a spectator if you

wish) the pearls are all threaded in a row on the thread.

Method: A pull on the left side is attached to the film container. The left hand holds it between thumb and first two fingers. It has no cap on it. The cap lies on the table behind other equipment, with a duplicate film container, complete with cap, loaded with a string of pearls.

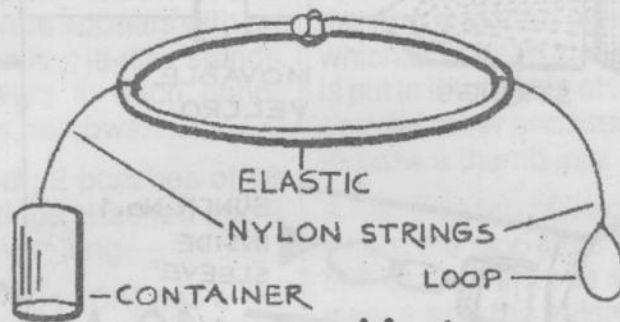

11-A

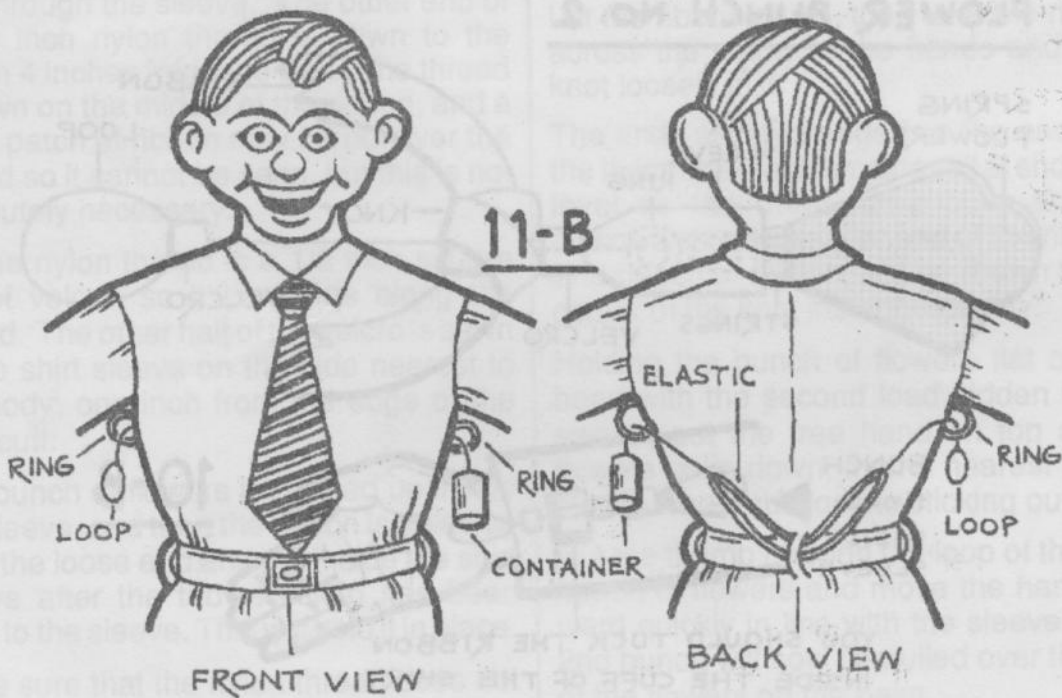

Loose pearls are now dropped clearly into the pull container, then a length of thread, and then you reach for the cap. The duplicate is palmed at the same time as the cap is picked up.

When the cap is pressed on to the pull container, the fingers holding the container grip the duplicate from the other hand, then release the pull when the duplicate is removed by the other hand.

This is moved away from the body and shaken as the pull flies away. The sound of the shaking covers any noise made by the loose beads as they are pulled out of sight. *Isn't that a pretty neat switch?*

Toss out the duplicate canister holding the string of pearls, and show everyone.

This effect is presented as a demonstration of magical skill. Putting the beads and thread singly in the box, the magician says that if the box is shaken a few times, the chances are that one or two beads might get automatically threaded.

But he has perfected this shaking to such an extent that he hopes to get more than two on the thread. He moves his hand this way and that shaking it up and down, sideways and diagonally, until he declares it is done.

When he passes the box to a lady he asks her to carefully open it and find the thread's ends. The string of pearls is then removed

and shown.

Construction of Pull used for "A String of Pearls"

Two plastic rings (1/4") are stitched to the shirt at the armpit position shown in the diagram.

Take an 18" round or flat elastic and tie the ends together and form a big loop. Take two eight or ten inch nylon strings and fix a film container to one of the strings and attach the other end to the elastic.

Take the second string, form a loop at one end and attach the other end to the elastic as you have done before. This forms a twin pull using one elastic. (Fig. 11A)

Now to fix it, pass the nylon with the loop through one of the plastic rings (*from front to the back*) and pass through the belt loop of the pant and pass the same through the other ring but from behind to the front. (Fig. 11B).

Fix some object, a silk, or a piece of rope to the loop to prevent it from slipping away due to the tension of the elastic.

Now the pull is ready for performing "A String of Pearls" trick. The loop side of the pull can be used during the course of your show either to vanish a silk, a piece of rope etc.

Introducing A. K. Dutt



Arun Kumar Dutt was born in 1955 and was married to Suma in 1980. Even as a boy, Arun, the youngest member of his family of 2 brothers and 2 sisters, was very interested in Magic. He saw a show in Bangalore where Mr. Ramesh Rao's son performed magic. Arun believed it was done by supernatural powers and he longed to learn how to perform such miracles.

Only after he graduated was Arun able to meet Mr. Ramesh Rao who showed him how to perform a few card tricks. Arun went to see every magician's show that he could, and at one of them he met Prof. Vasanth Kumar who agreed to teach him magic. Travelling 70 kms. for lessons, Arun studied for a year and learned about dealers, larger tricks and other magicians. His first show was given in 1977 for a Christian Missionary at Tumkur.

In 1982 the popular magician Caliph of Sri Lanka came to Bangalore for a convention organised by Dynamic Ramesh. At this convention Arun met Zzesto (Mr. Ramaswamy). They had much in common, including similar appearance, both had full beards. They decided to team up as Presto & Zzesto the magical twins. Together they did many large commercial shows with full stage settings, assistants and illusions.

At this time Arun was advised by Dynamic Ramesh to concentrate on one specific branch of magic and become expert in that field. Arun chose flower and silk magic after he saw Goutam Guha's lecture on Flower magic at Bombay I.B.M. Convention in 1988. Since then Arun has worked only on this subject. He has invented his own holders and pockets for body loads (*he carries twelve bunches, plus garlands, a shower of 50 flowers, Dream silks, Blendo, 20th Century Silks, all in body loads*).

His own versions of pulls, and of silk effects, thimbles, gramophone records and a host of other original effects now make up his silent act. His wife Suma does the backstage work of tailoring as well as the job of assisting Arun on stage in performances.

Arun's full act will be written up and published as a book later on. Arun plays the Banjo and enjoys a good game of Chess and Table Tennis.

Once a month Arun gives a free show for such charities as physically handicapped people, sick children and hospitals, orphanages etc.

Arun loves to read books on magic and has been helped in this by Zzesto (Ramaswamy), Ramesh and Mahadevananda who have lent him their libraries freely. Keen to learn ever more about Magic, Arun is looking forward to working on more new magic for another act he wishes to perfect.

Mahadevananda